







 Ø6,3x50 mm A1 x 21	 Ø12 mm A2 x 21	 4 mm A3 x 1	 Ø15x12 mm B1 x 10	 Ø5x44 mm B2 x 10
 Ø20 mm B3 x 10	 Ø4x16 mm D1 x 32	 Ø1,6x25 mm F x 58	 Ø8x36 mm G x 19	 Ø5x16 mm L x 4
 K x 1	 M x 2	 N x 6		

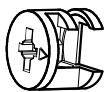
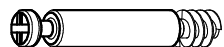

Box 1 / 1

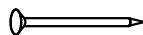
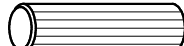
677x411x3 mm

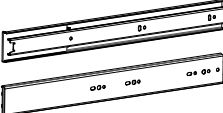
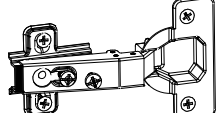

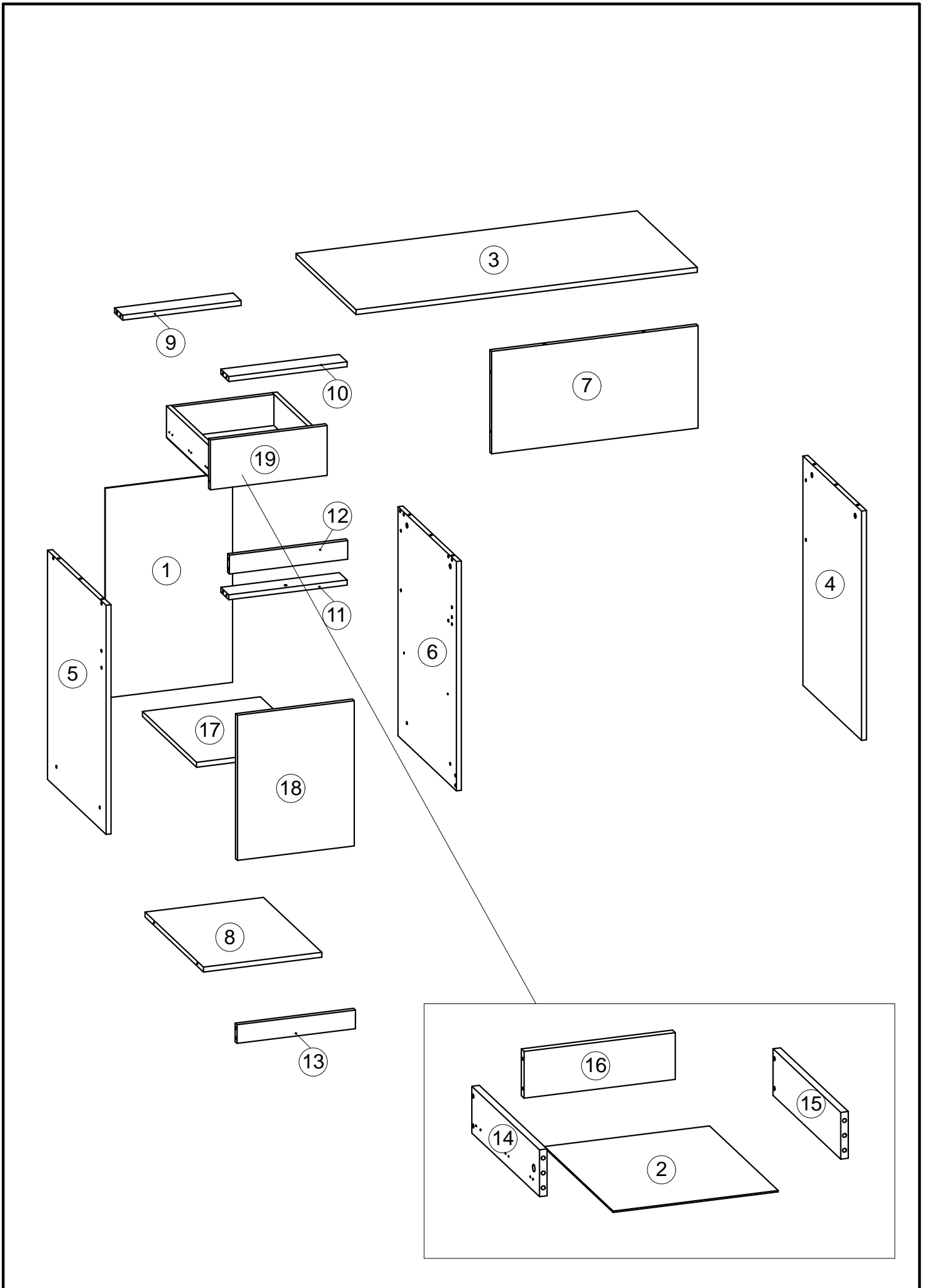
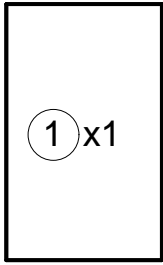
739x518x16 mm

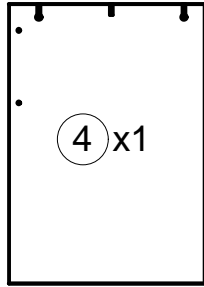

739x518x16 mm

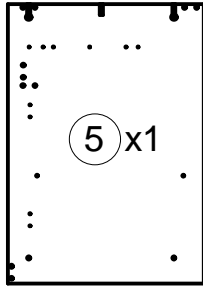

739x518x16 mm

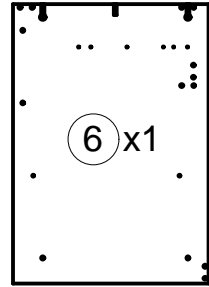

406x355x3 mm

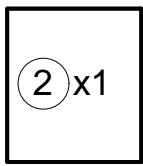

382x70x16 mm

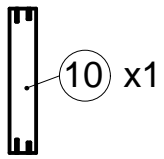

400x100x16 mm

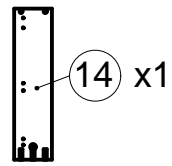

400x100x16 mm

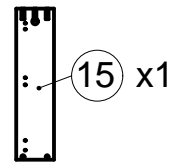

325x100x16 mm

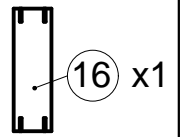

666x330x16 mm

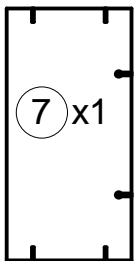

382x518x16 mm

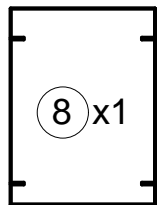

160x376x16 mm

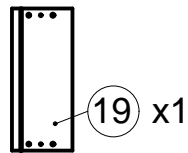

478x381x16 mm

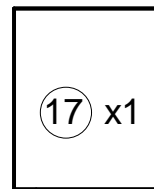

382x70x16 mm

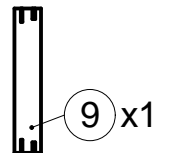

Fittings & Tools

382x70x16 mm

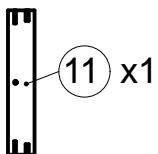

382x60x16 mm

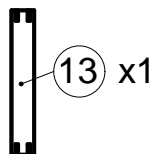

382x60x16 mm

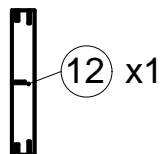

467x376x16 mm

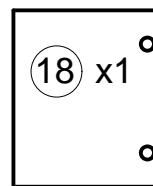

Box 2 / 2

1100x530x16 mm

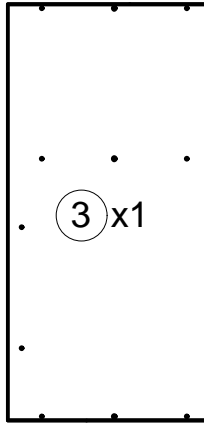

1

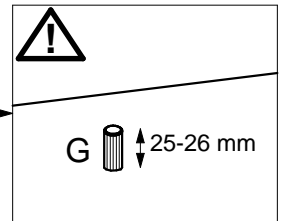
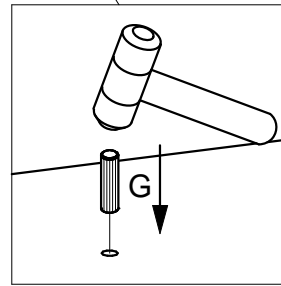
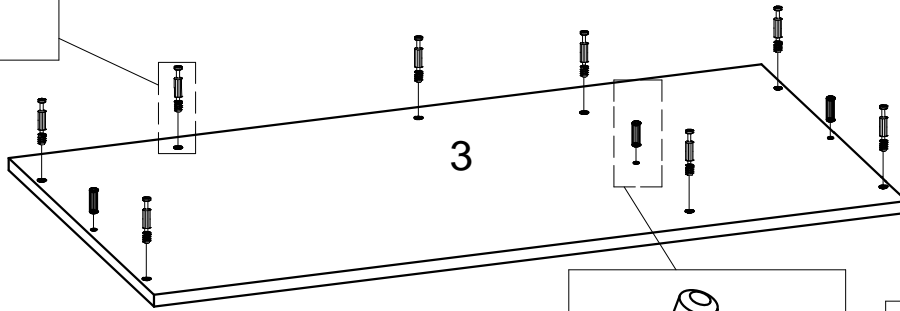
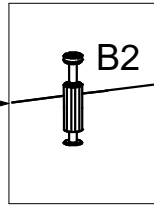
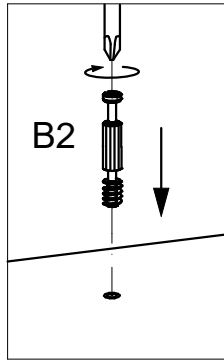
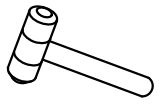
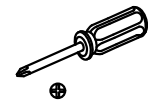
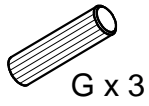
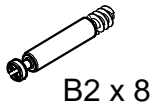

2

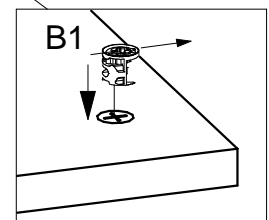
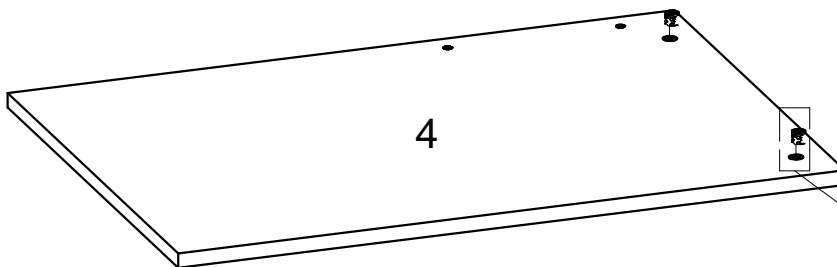
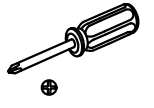
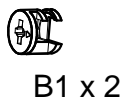

3



B1 x 2



G x 6



L x 2

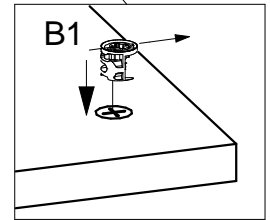
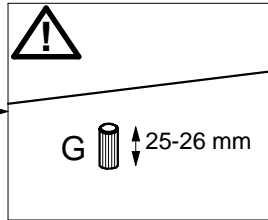
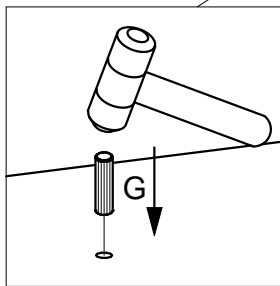
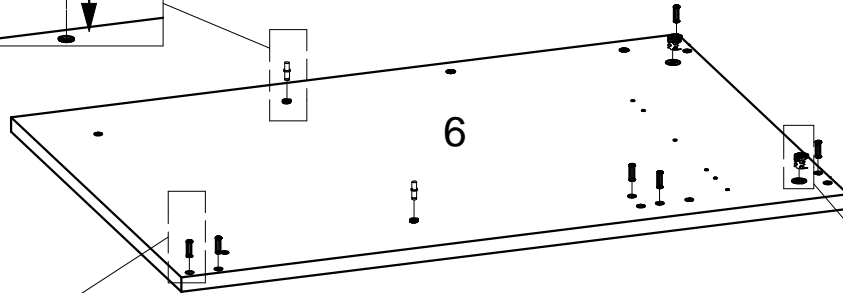
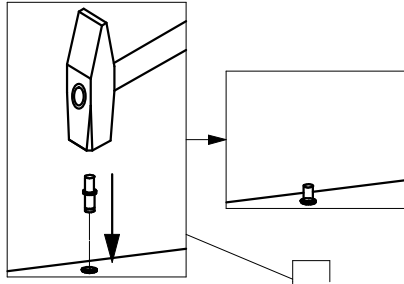
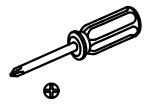
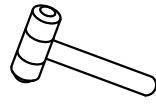
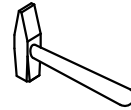

4



D1 x 3

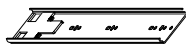

K.1 x 1

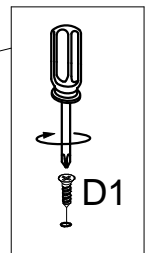
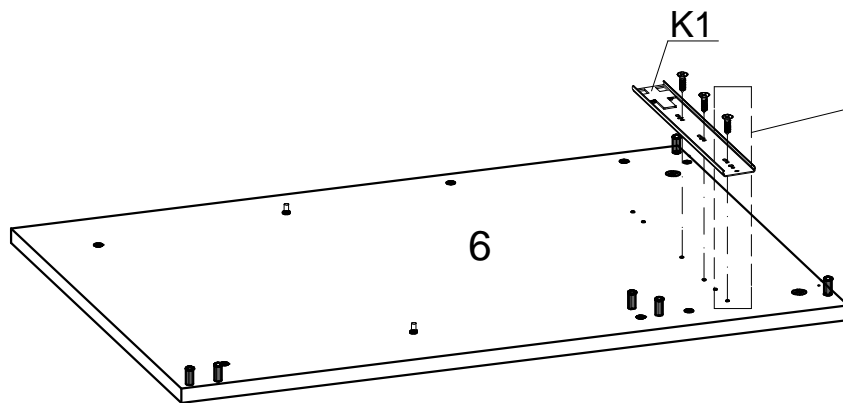
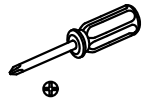

5

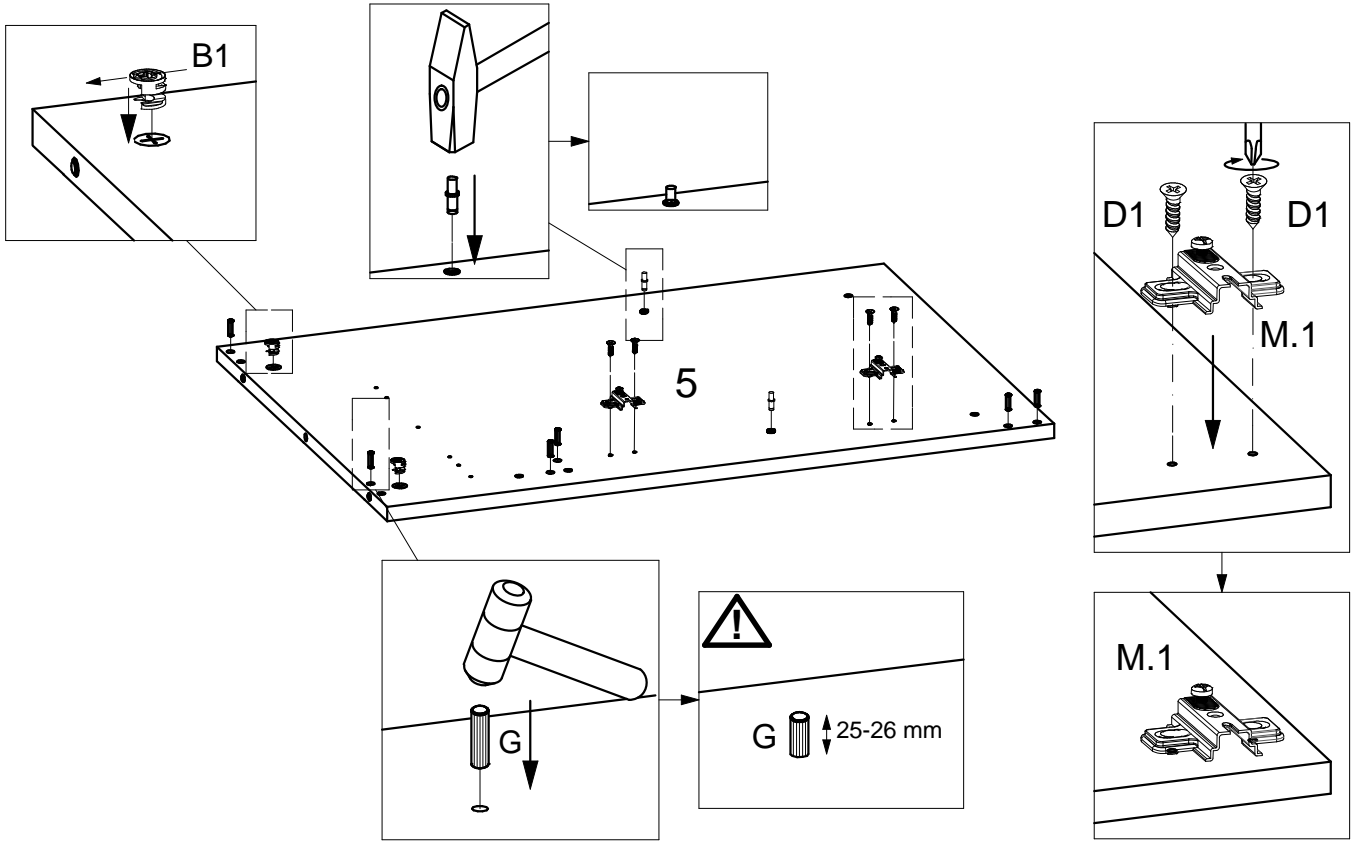
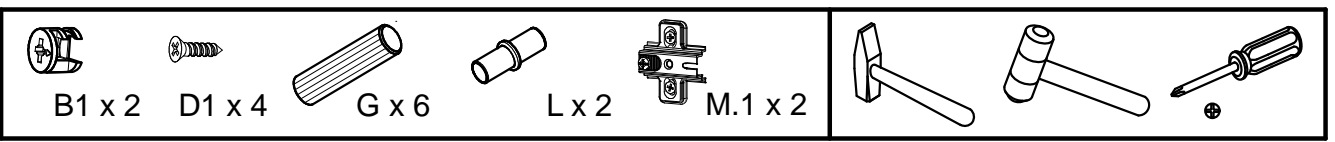

6

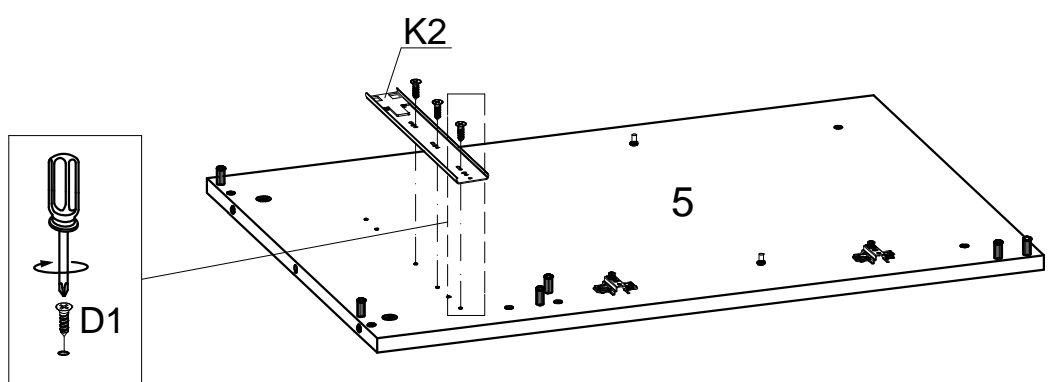

7



B1 x 2

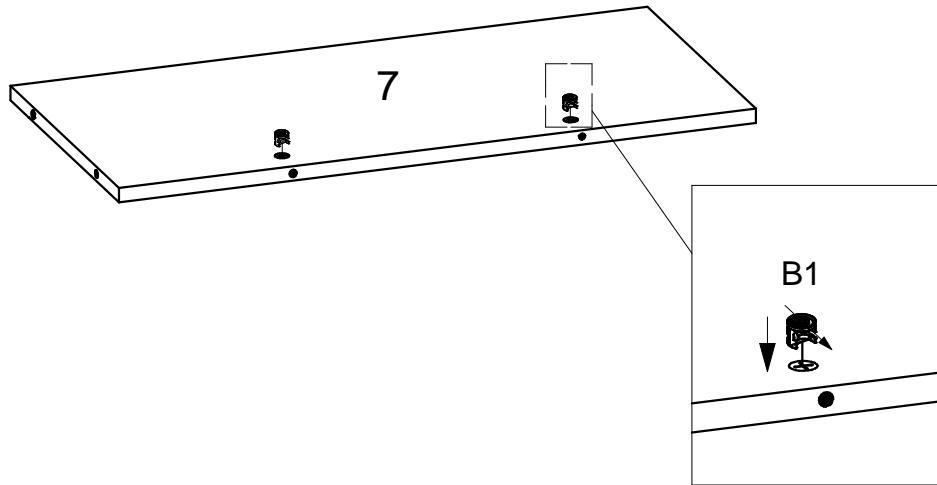
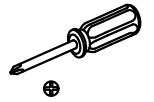

8



D1 x 4

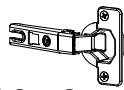

M.2 x 2

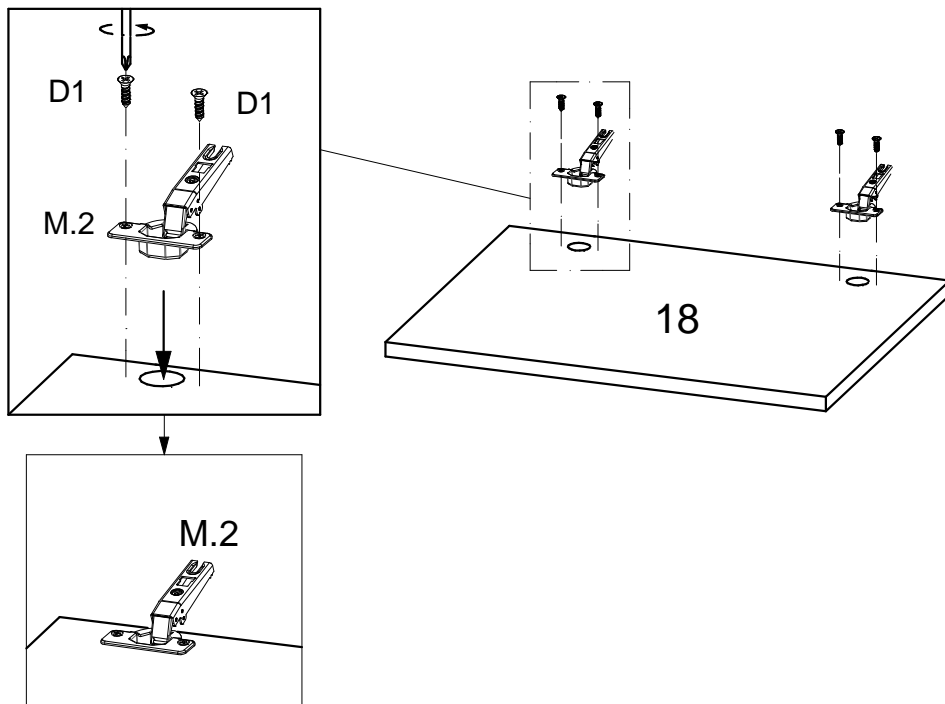
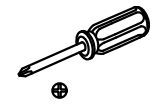

9

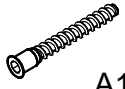

A1 x 1



A2 x 1



A3 x 1

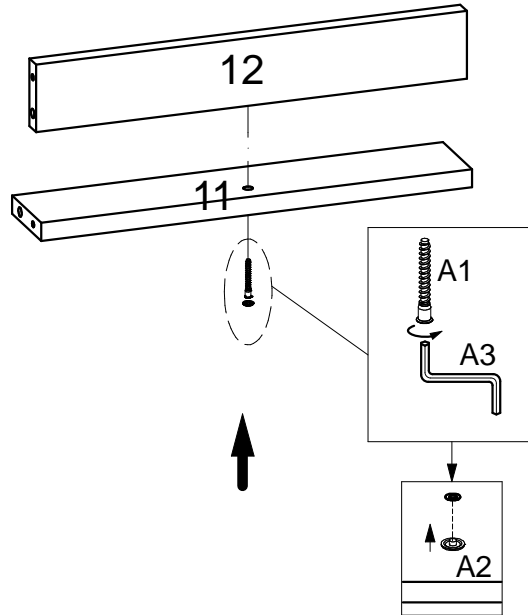

10

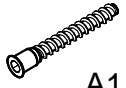

A1 x 12



A2 x 12



A3 x 1

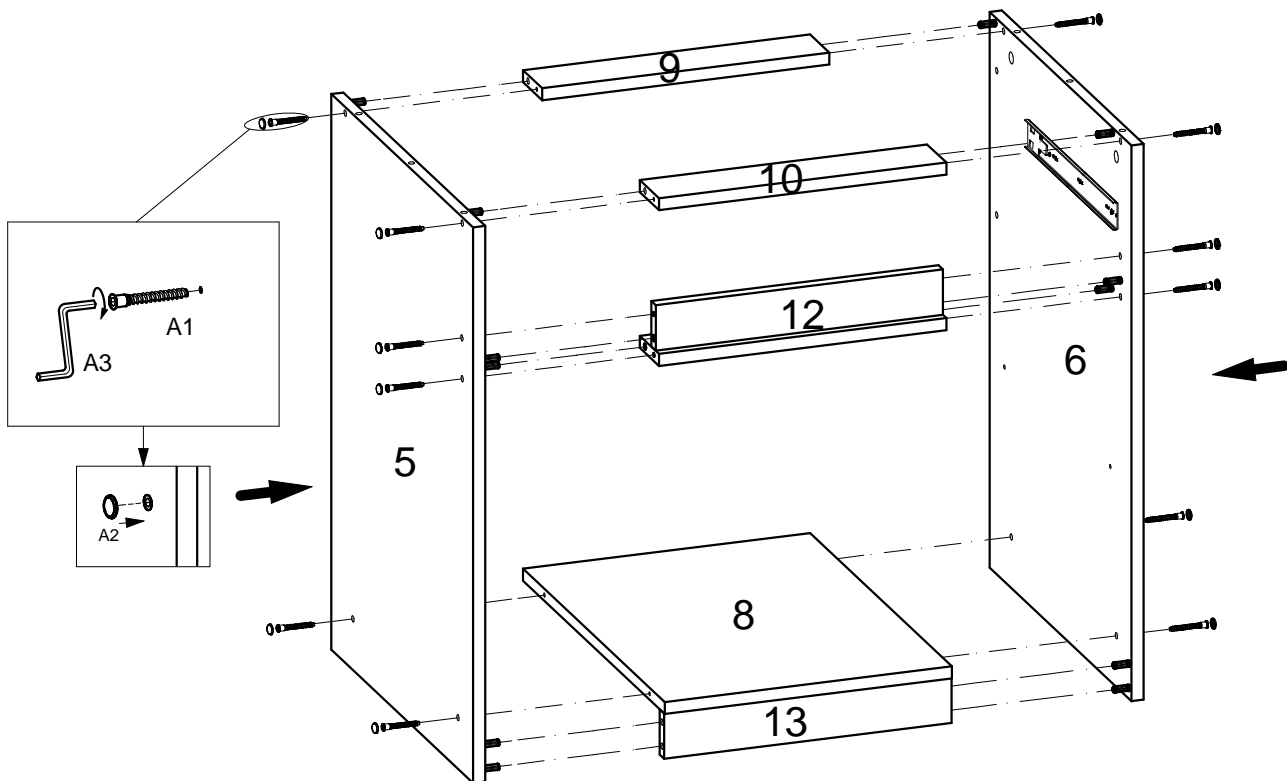
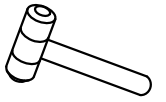

11

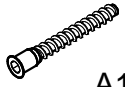

A1 x 4



A2 x 4



A3 x 1

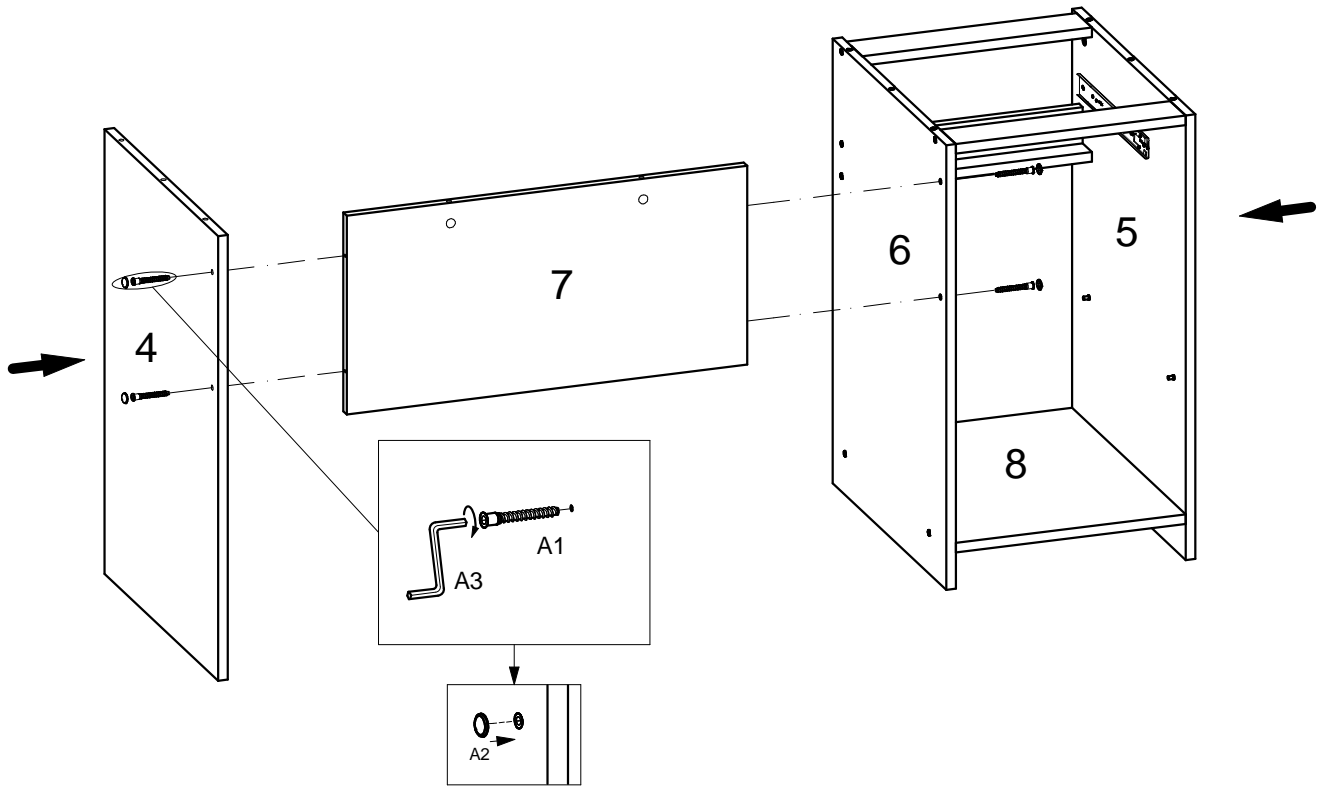

12



B3 x 8

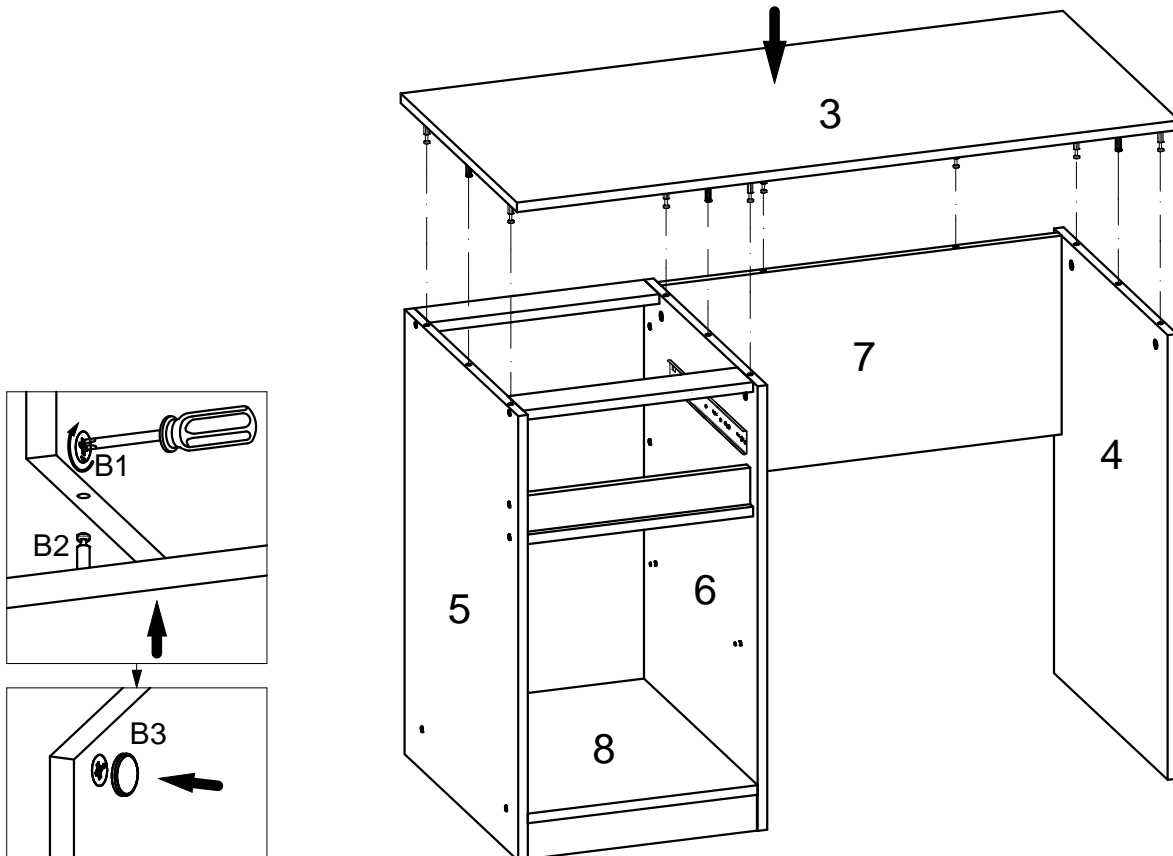
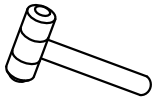

13



D1 x 12



N x 6

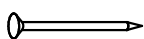

F x 36

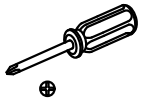
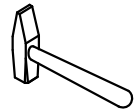

⚠ XX=YY≅90°

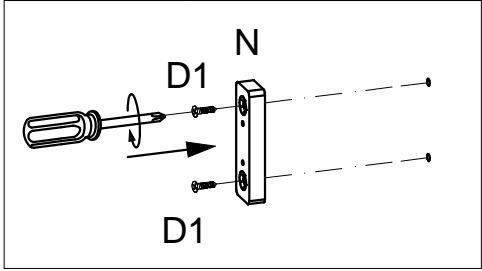
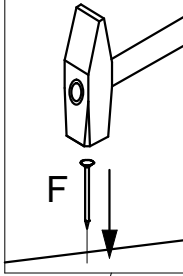
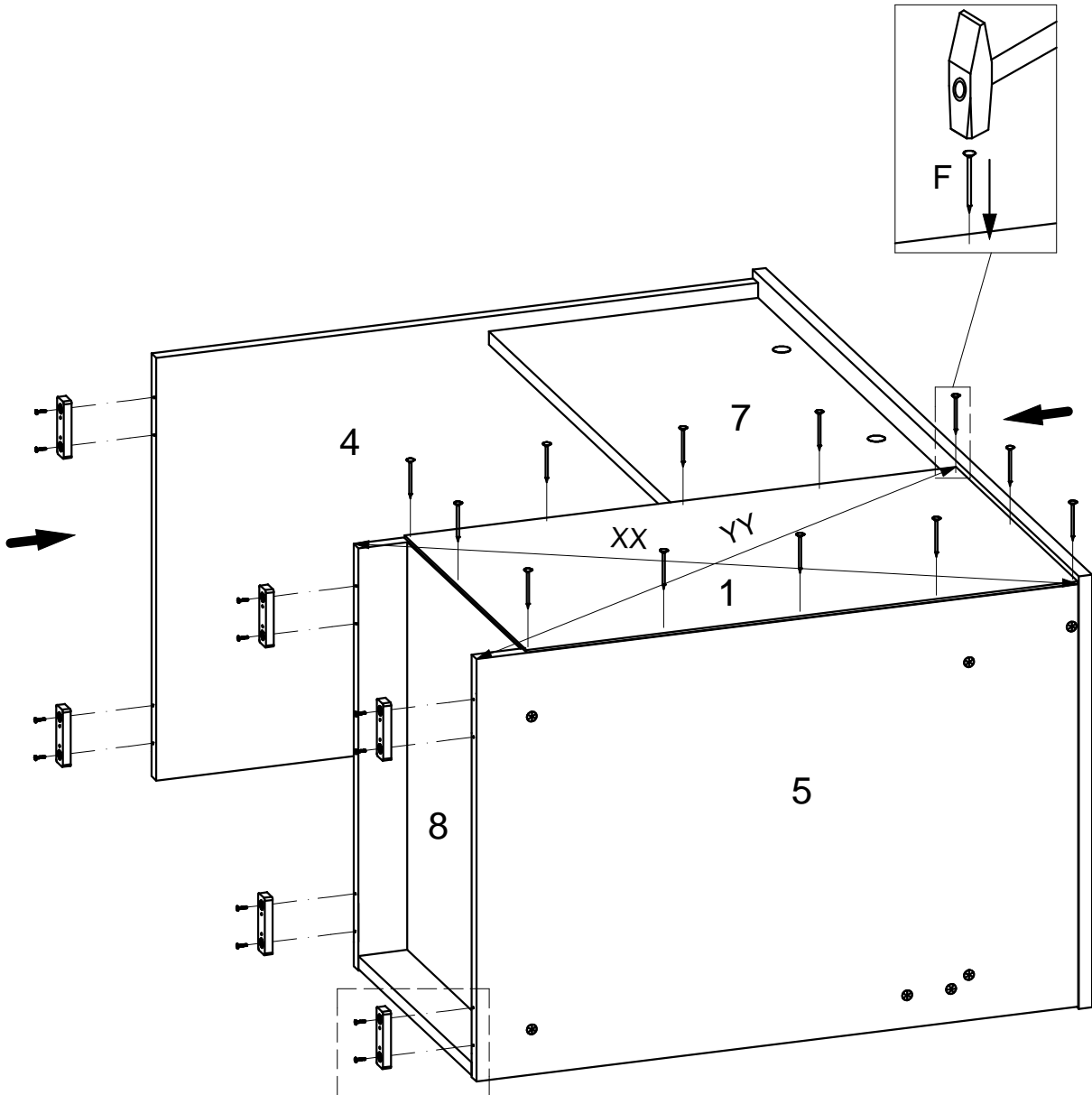

14



A1 x 4



A2 x 4



A3 x 1



B1 x 2

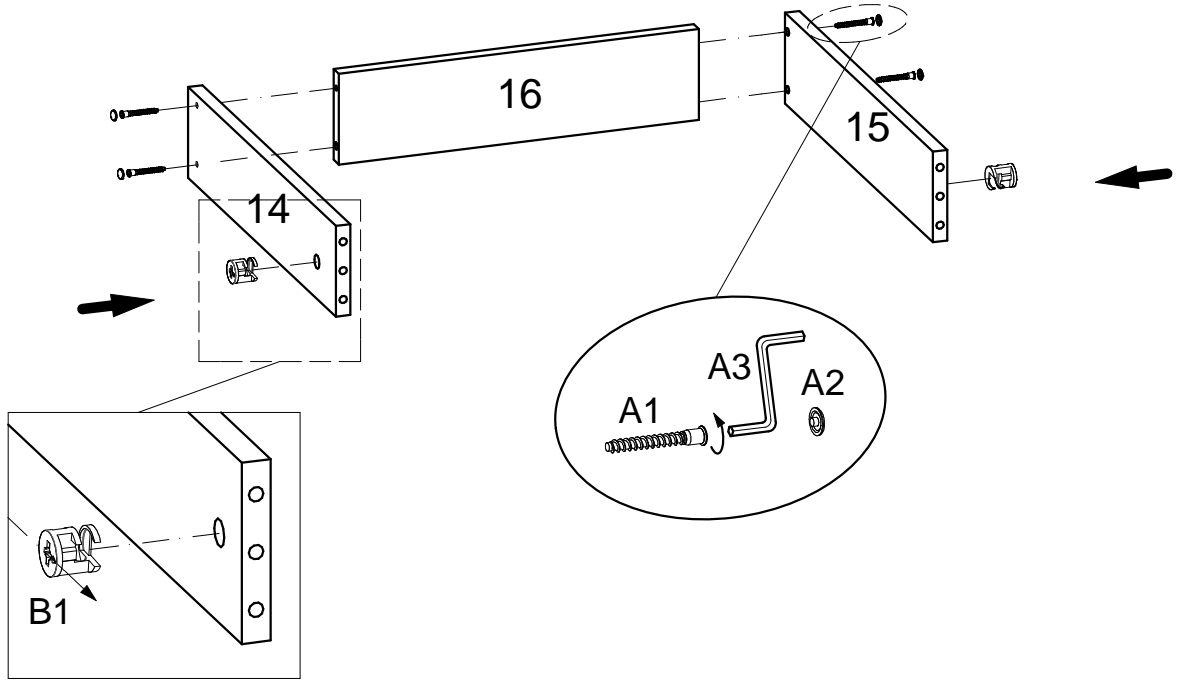

15

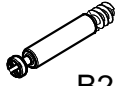

B2 x 2



B3 x 2



G x 4

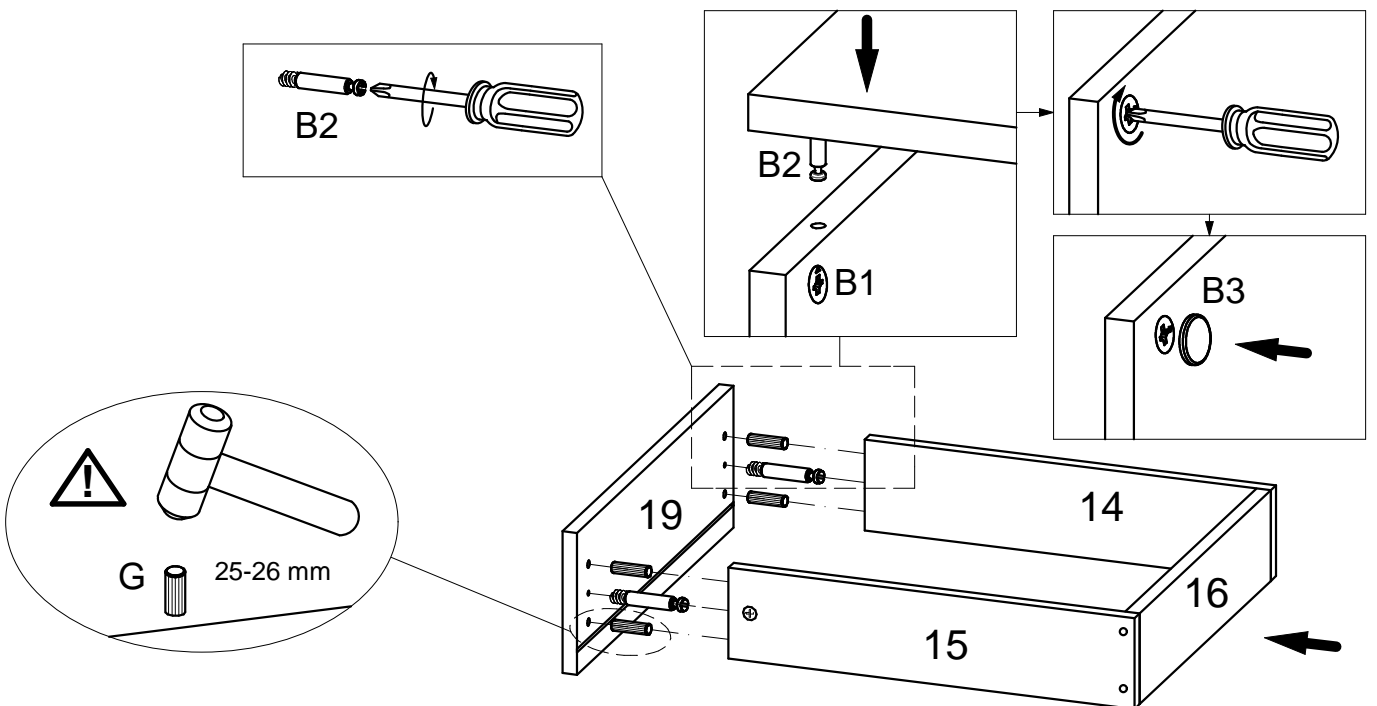
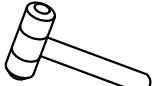
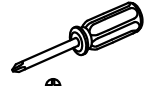

16

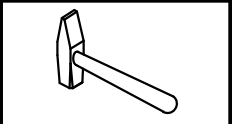
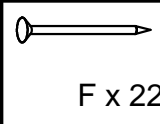

⚠ XX=YY≅90°

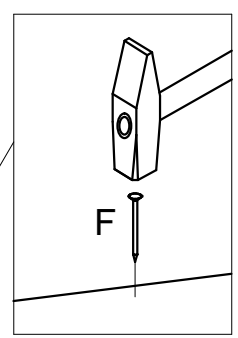
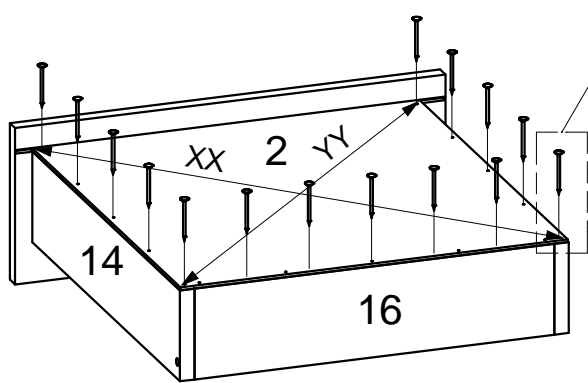

17

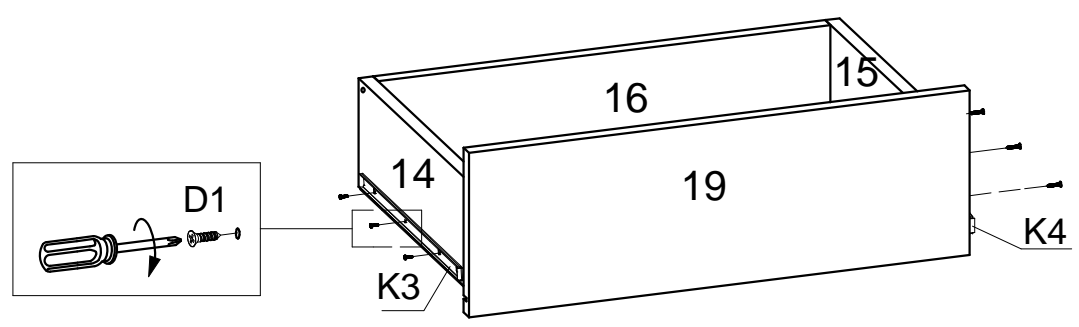
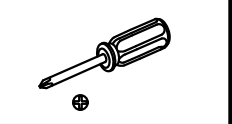
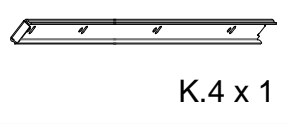
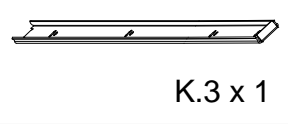

18

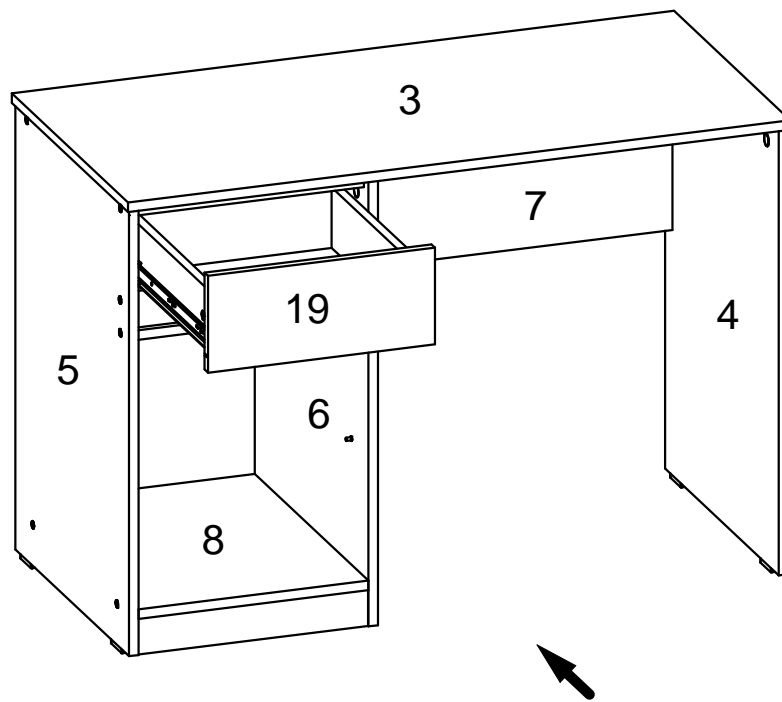

19

